



MAQUINADOS Y
HERRAMIENTAS
INDUSTRIALES

FER-AL

Transformamos sus ideas en acero

PRODUCIMOS

- Herramientales
- Montaduras
- Pinzas de sujeción
- Piezas sobre diseño
- Herramientas de corte

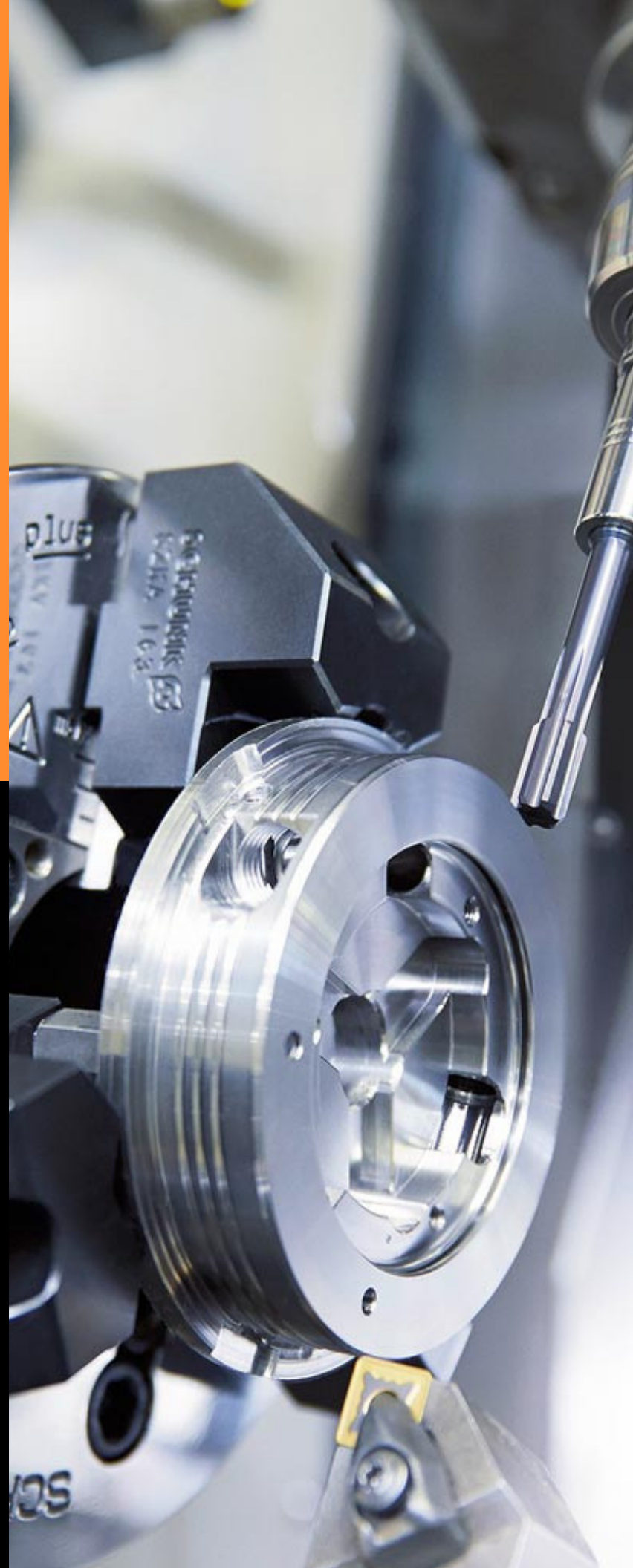



QUIENES
SOMOS

UNA EMPRESA CUYA BASE ES EL MAQUINADO INDUSTRIAL.

**25 años de experiencia
en la fabricación de
piezas metálicas**

Ing. Fermín Cano Luna
Gerente General

Somos una empresa dedicada a la fabricación de productos cuya base es el maquinado industrial en toda su variedad, desde pinzas de expansión, montaduras de producción, hasta herramientas especiales.

Nos consideramos más como una empresa de servicio que como un taller de maquinados, esto es debido a que nuestra principal preocupación es satisfacer los requisitos de nuestros clientes con productos de calidad en tiempo y forma requeridos, estando a la par de sus necesidades y así, ofrecerle soluciones convincentes a sus problemas en turno.



QUE
HACEMOS

LO QUE LA INDUSTRIA REQUIERA

**Desde pinzas de expansión,
montaduras de producción,
hasta herramientas especiales.**

**Y ahora tenemos una nueva división:
"Herramientas de corte"**

Ing. Fermín Alejandro Cano
Jefe de Producción

Empleamos procesos que se enfocan en el fresado con máquinas convencionales, torneado convencional y torno de control numérico, así como rectificado plano y cilíndrico.

Contamos con proveedores de confianza que nos surten los insumos de polímeros, metales, tratamientos térmicos y termoquímicos y demás procesos utilizados en la fabricación de piezas mecánicas.

Nuestros Trabajos

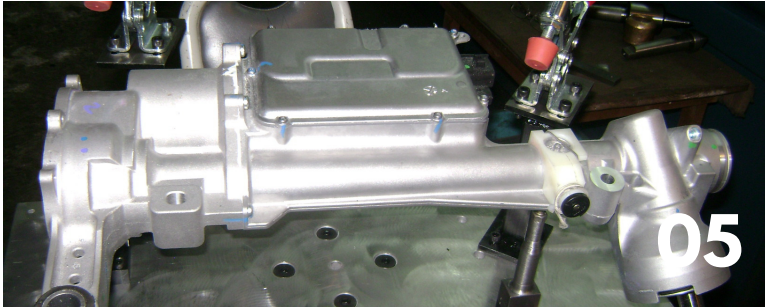

Herramientales

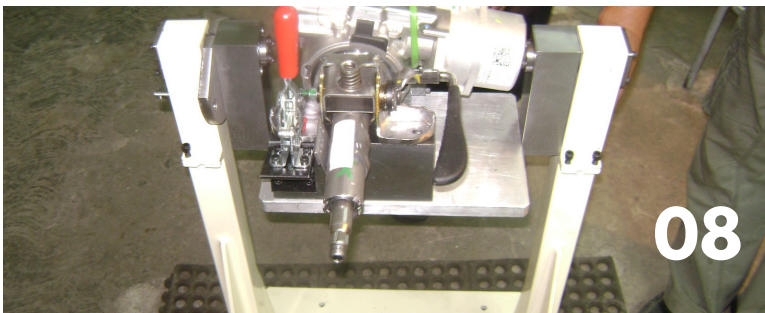

Montaduras



Pinzas de sujeción

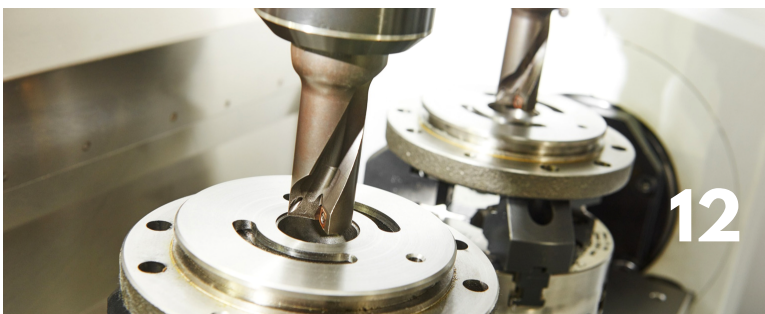

Maquinados



Herramientas

Herramientales



Banco de sujeción

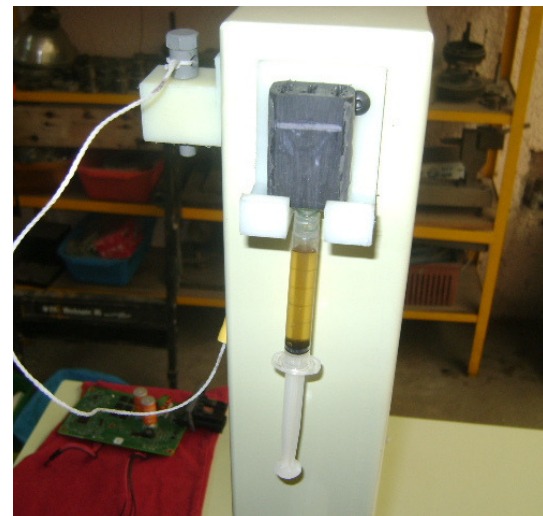

Herramientales



Escantillón

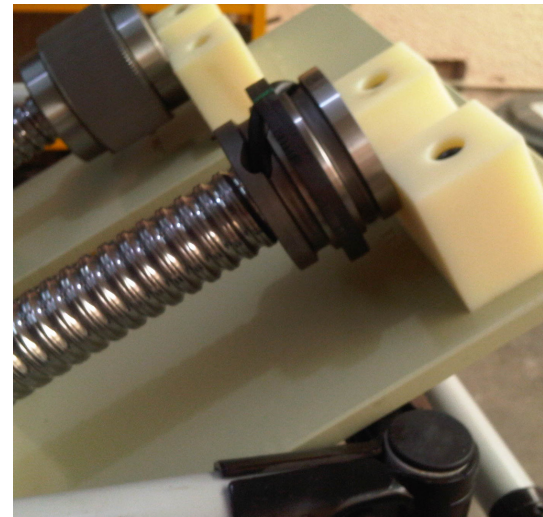

Herramientales

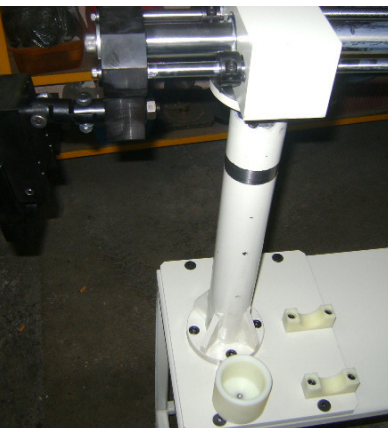
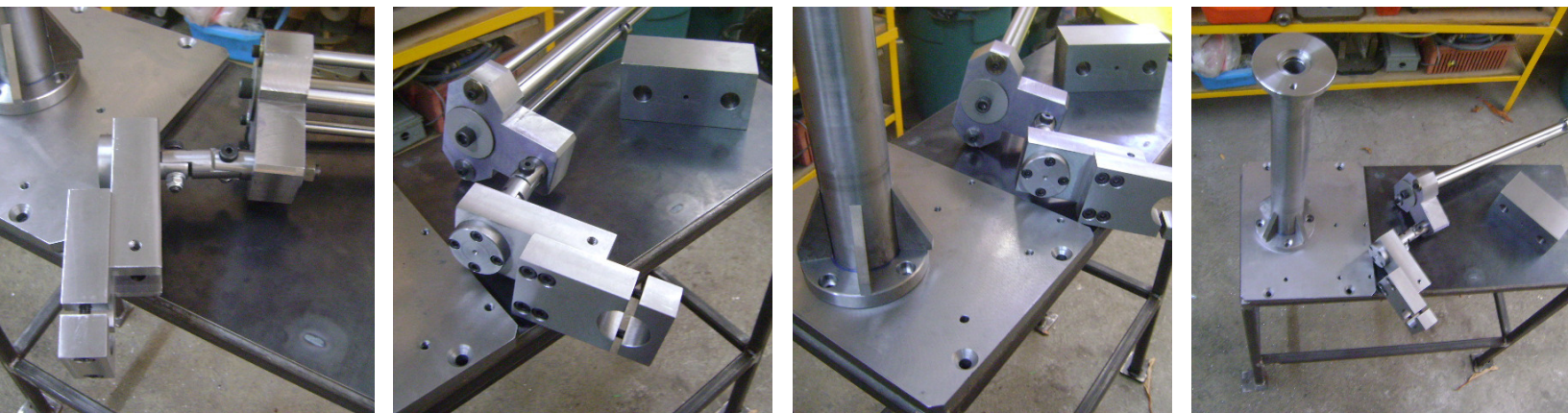

Montaduras

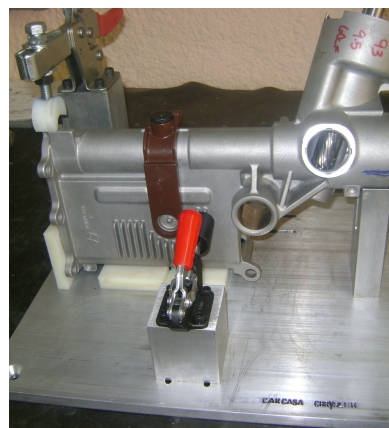
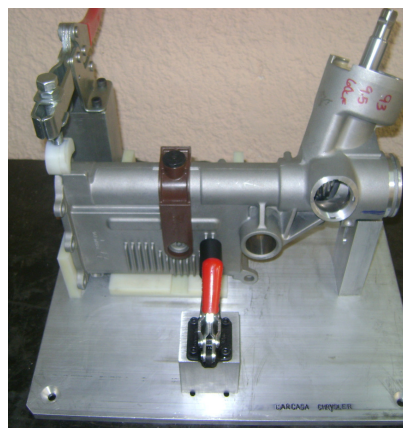
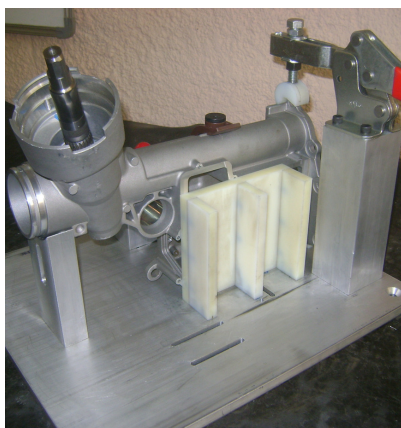
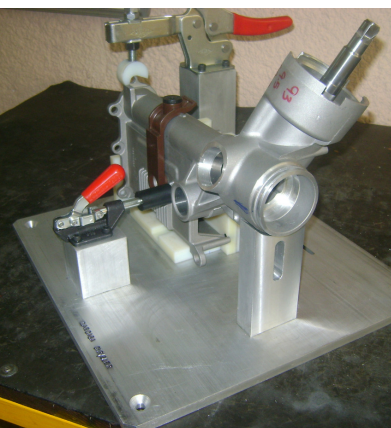
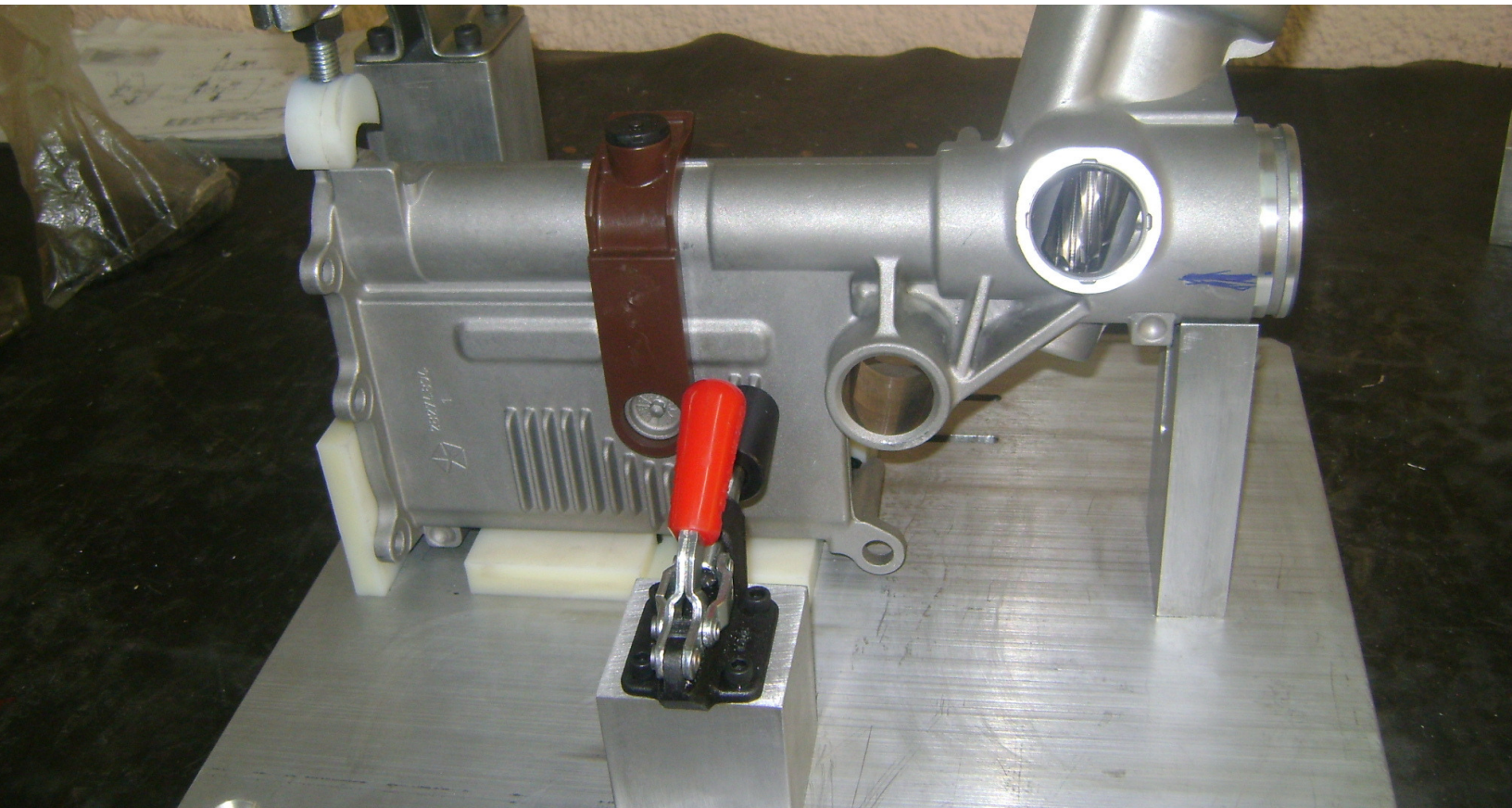
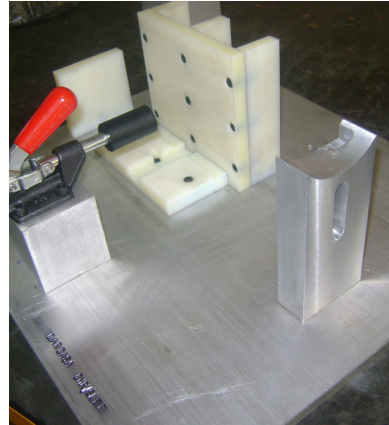
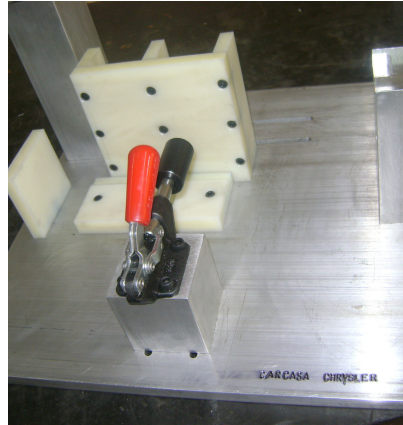
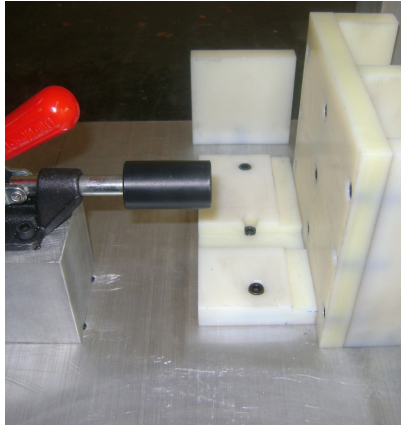
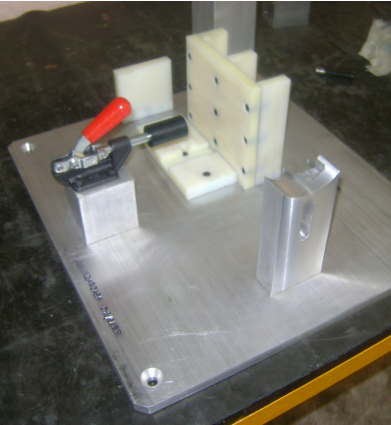

Montaduras

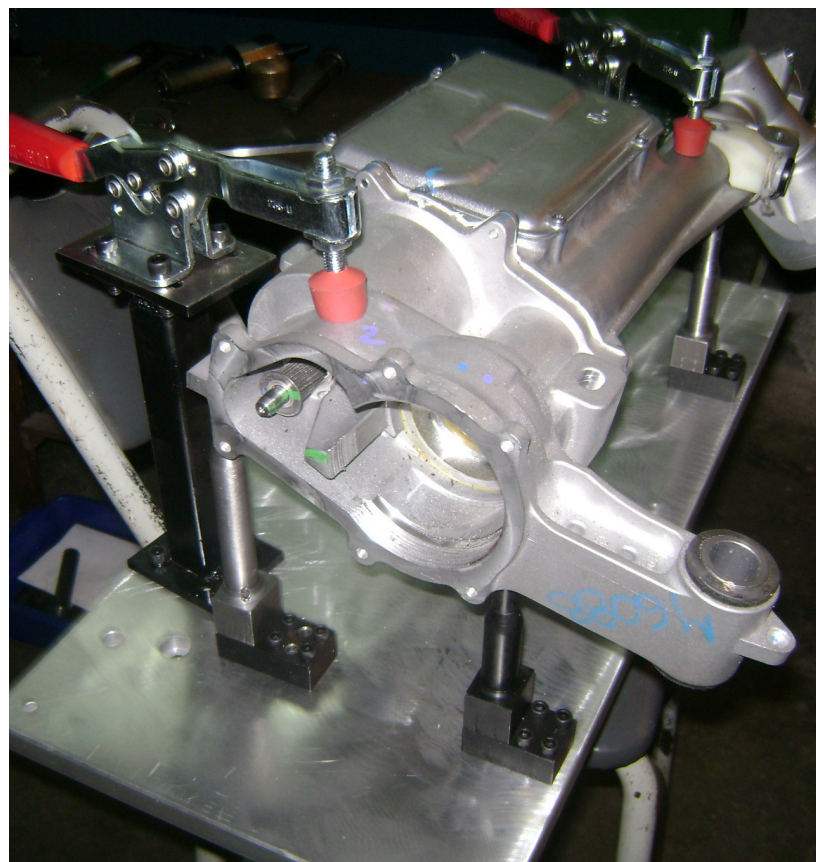
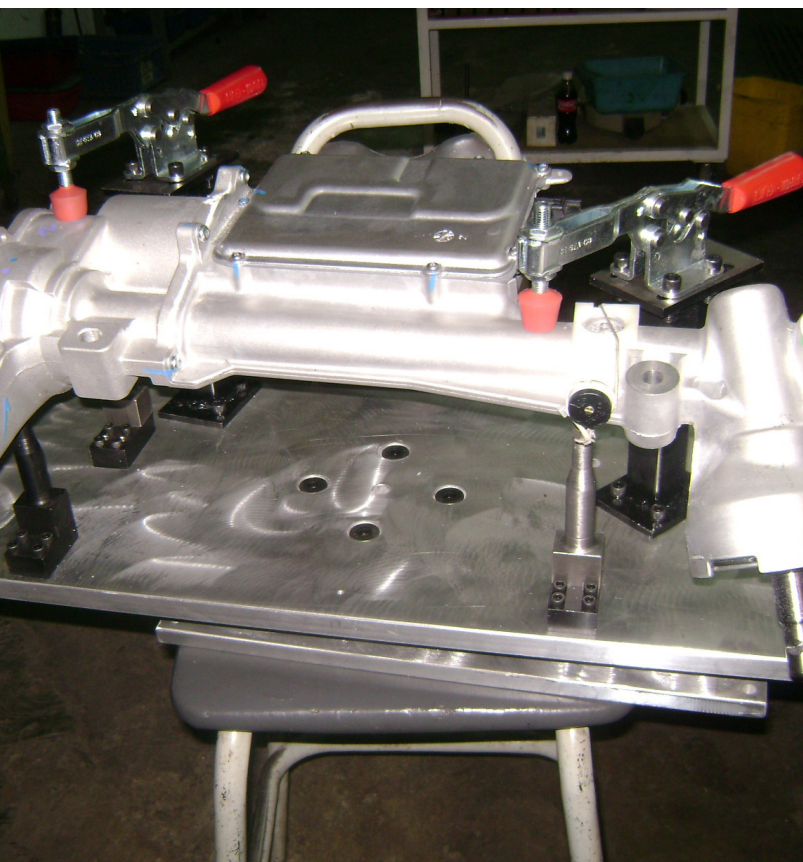
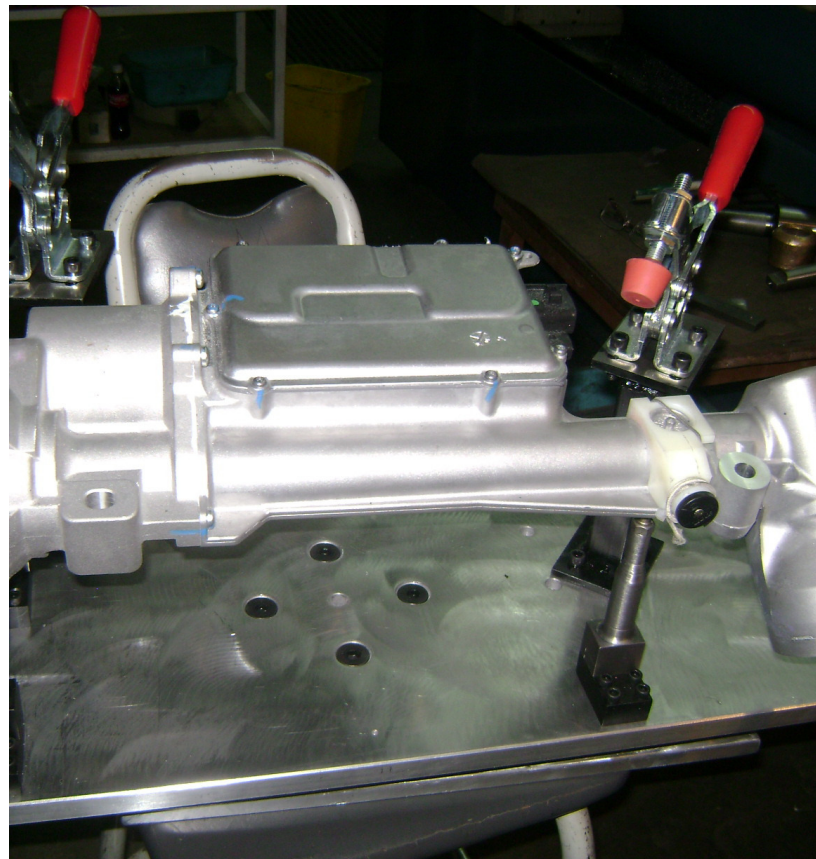

Montadoras

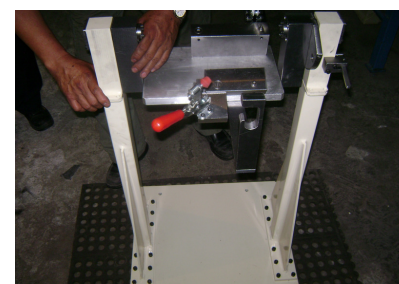
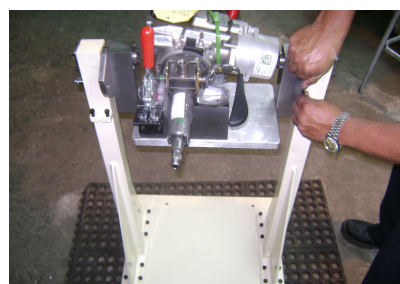
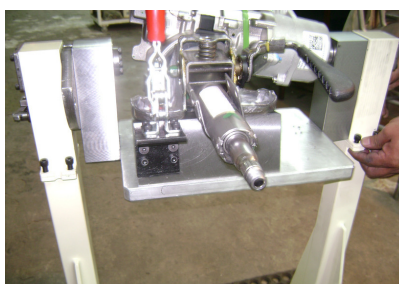
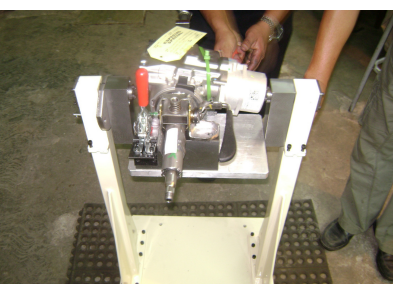
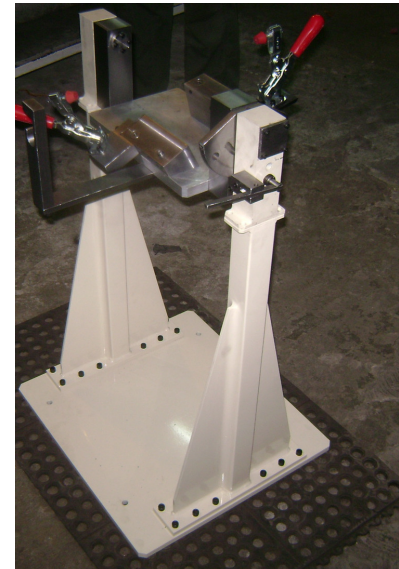
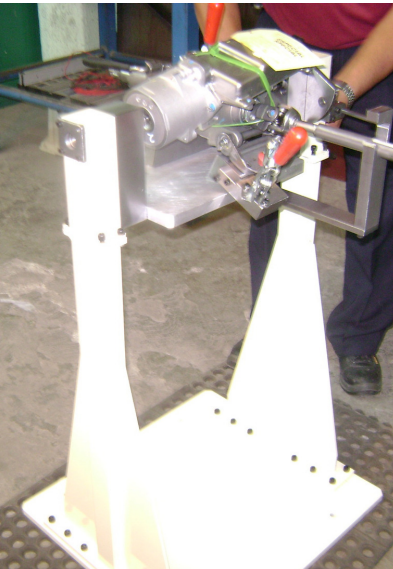
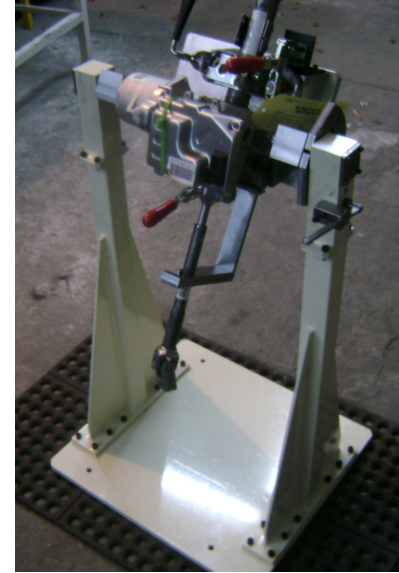
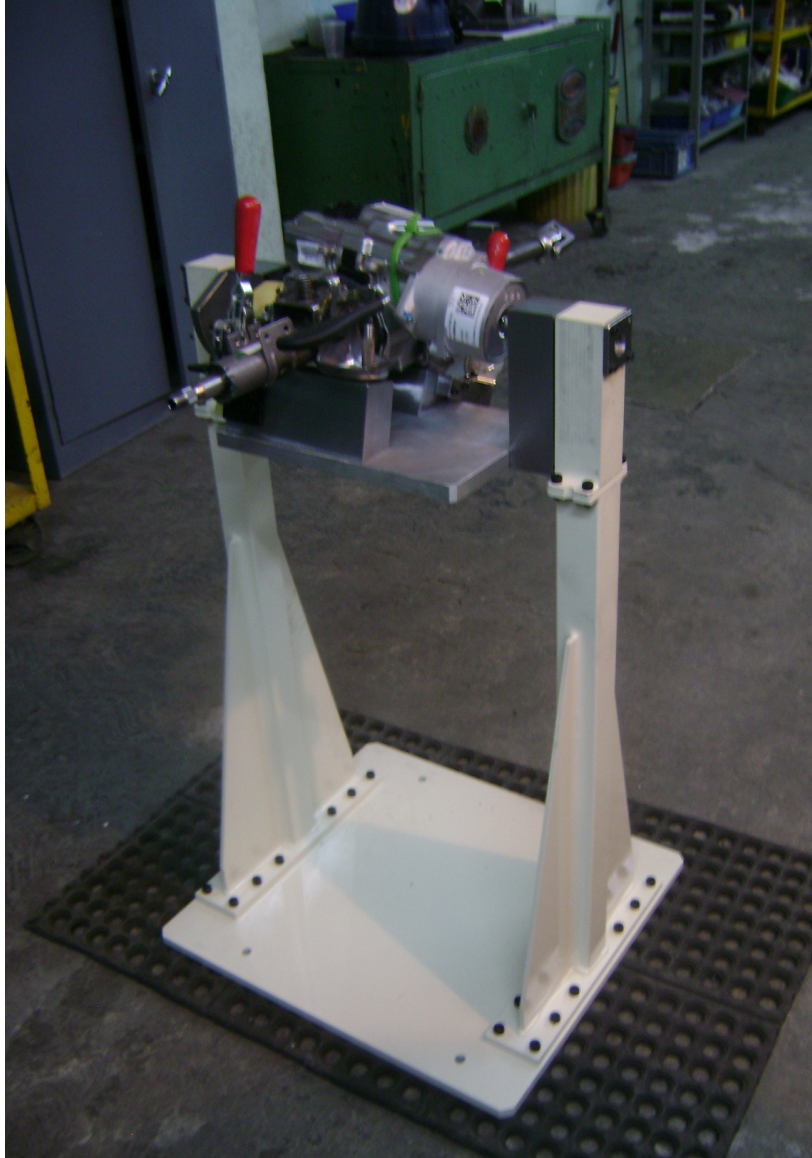
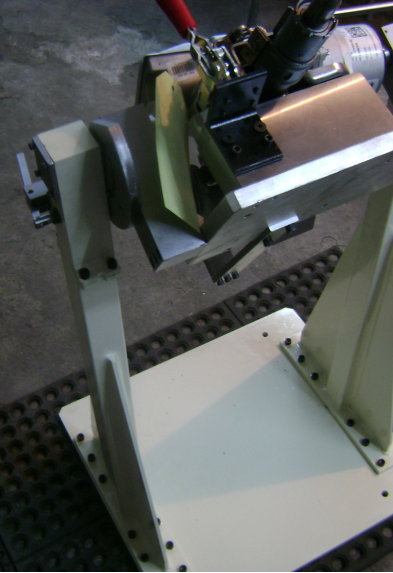
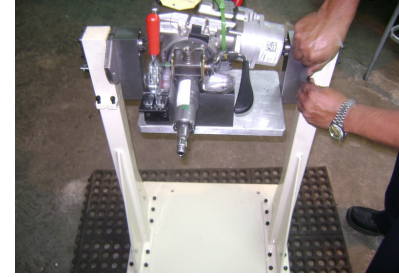
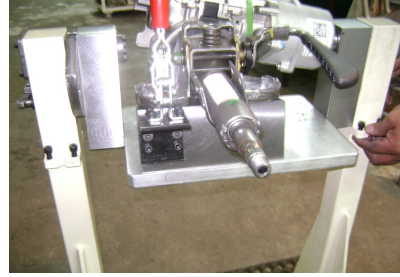
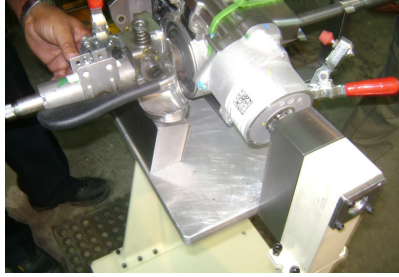
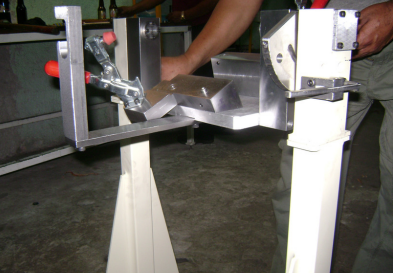

Pinzas de Sujeción



Maquinados

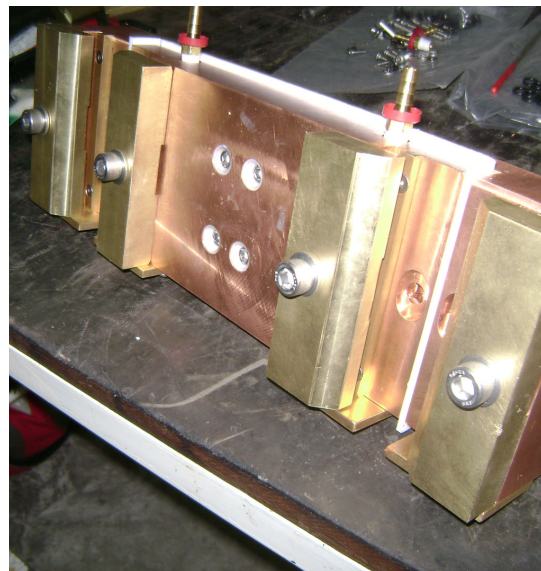
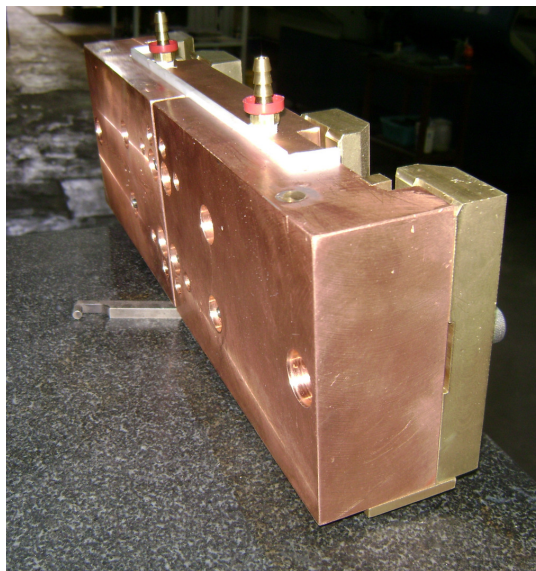
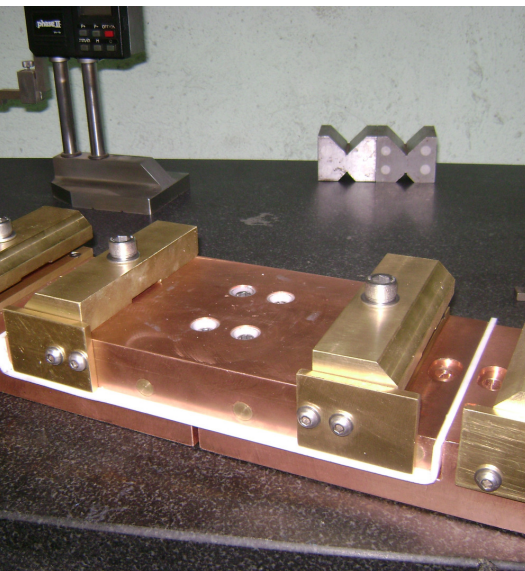
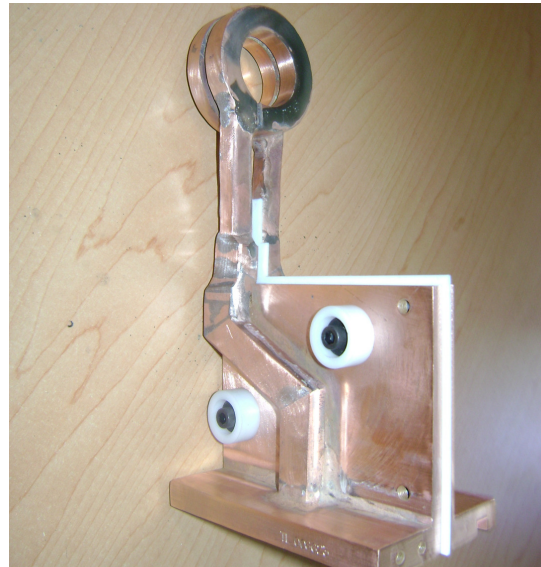

Maquinados



Maquinados

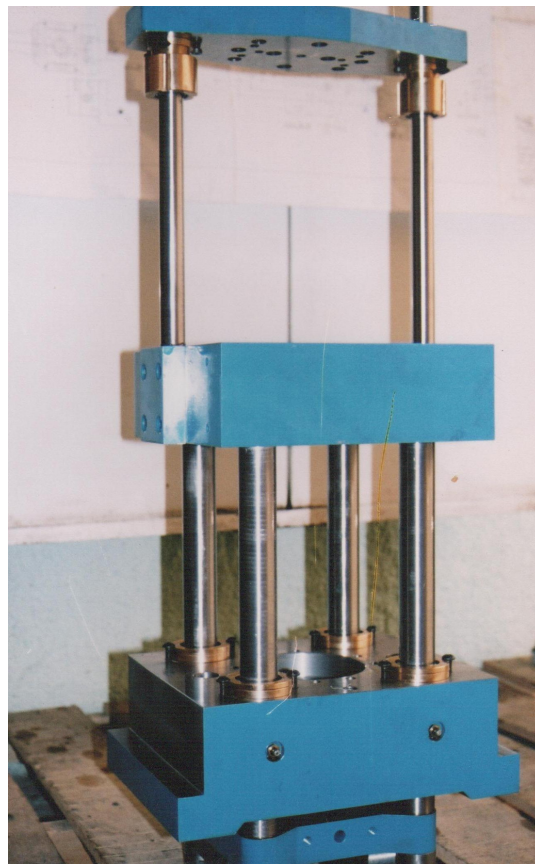
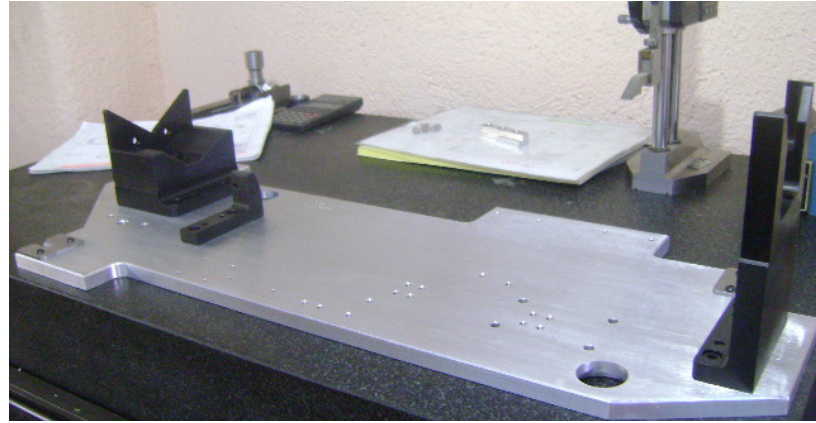
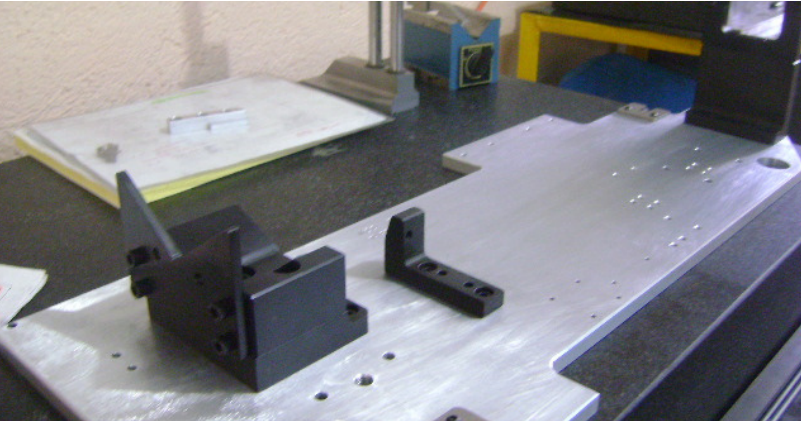

Maquinados

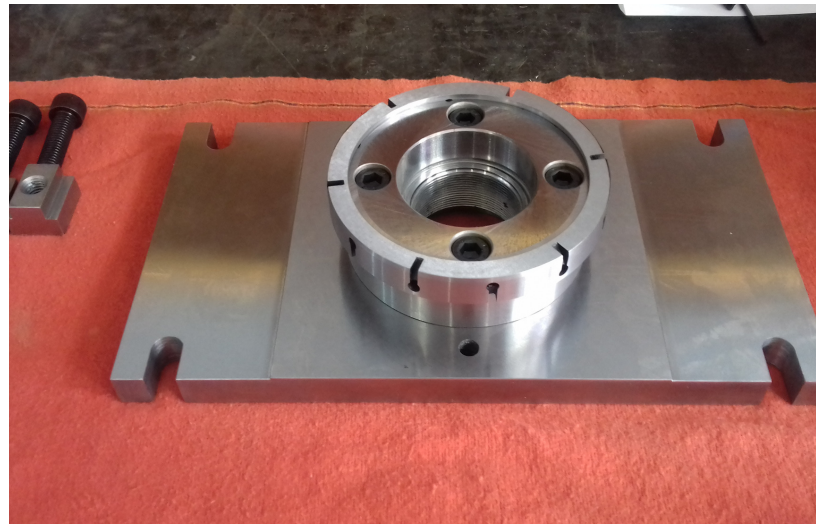
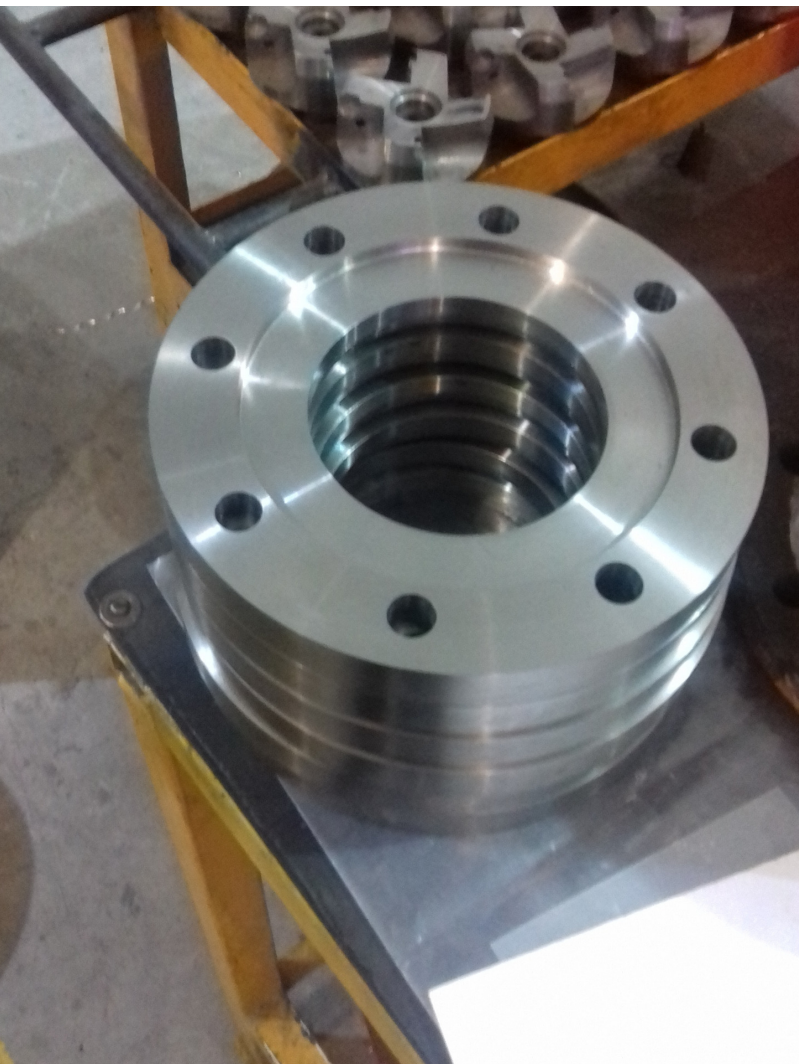
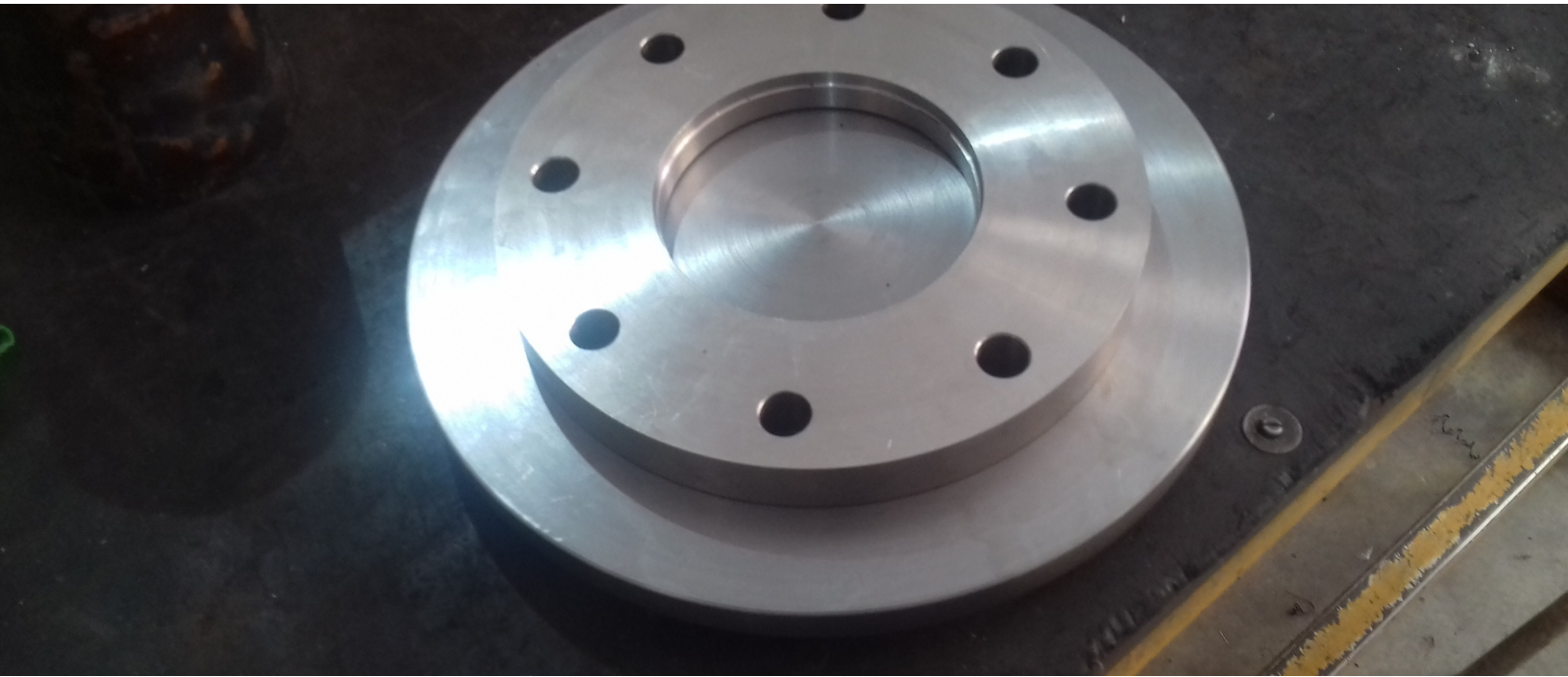

Maquinados

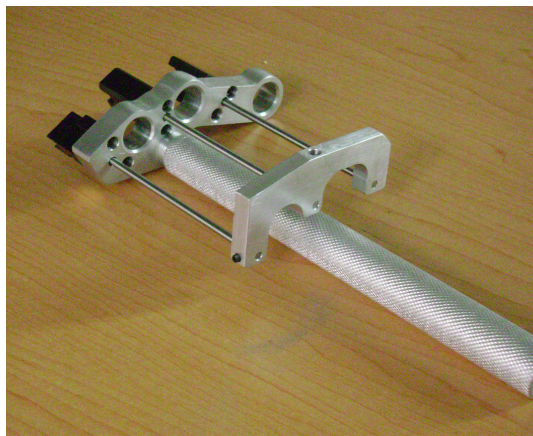
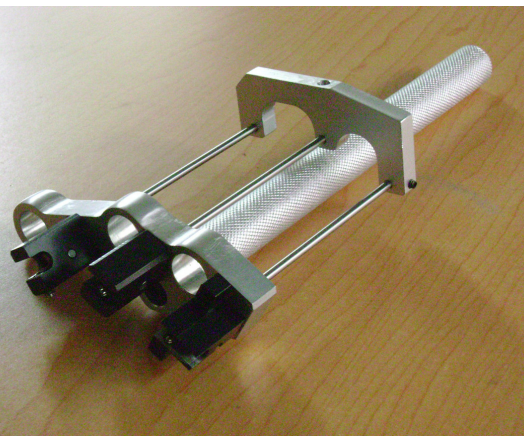
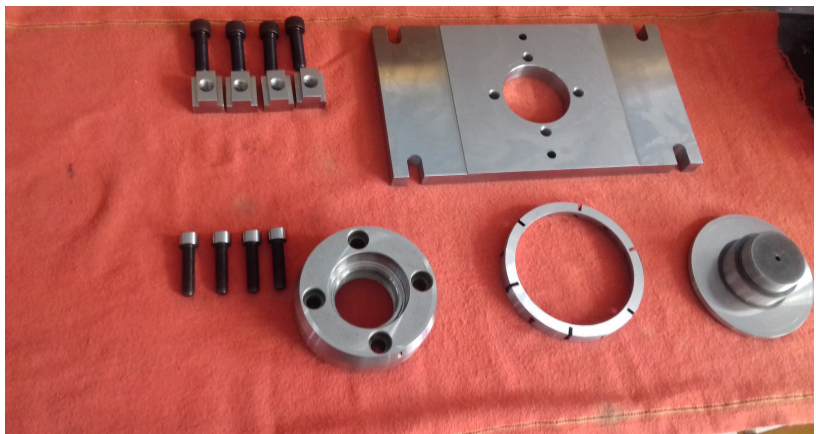
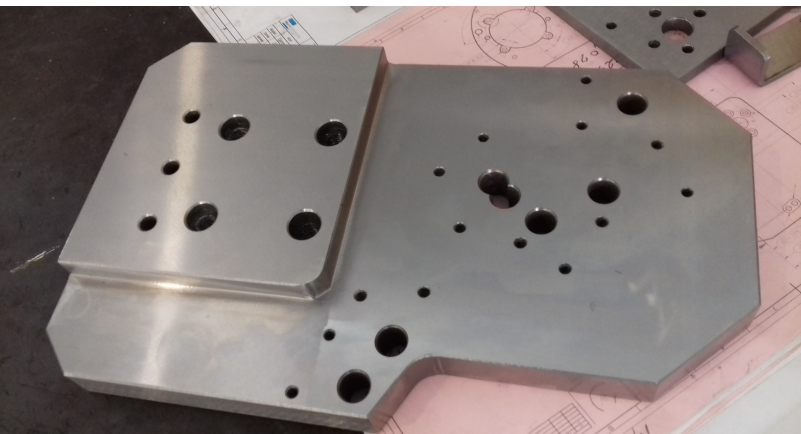
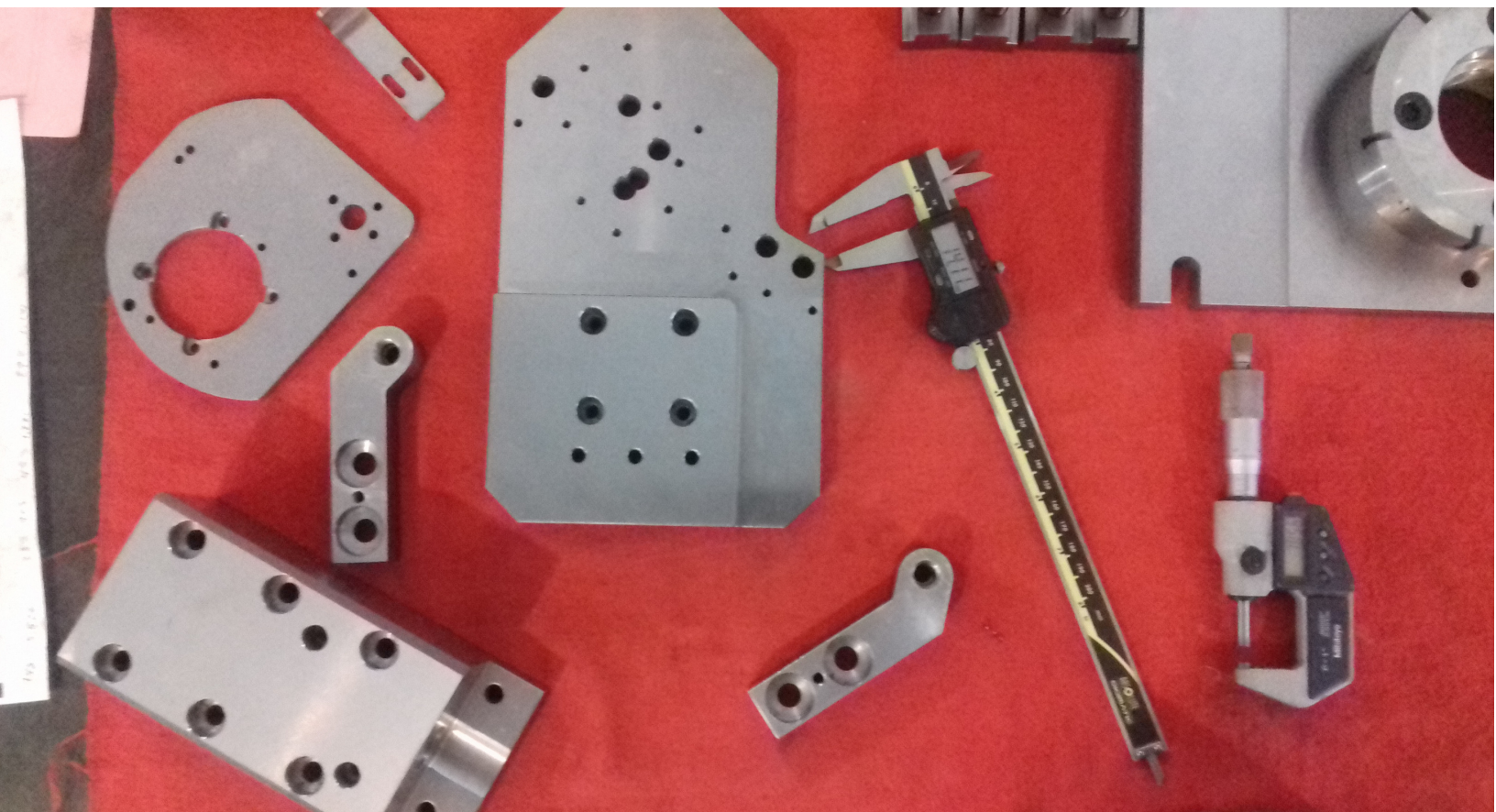

Herramientas

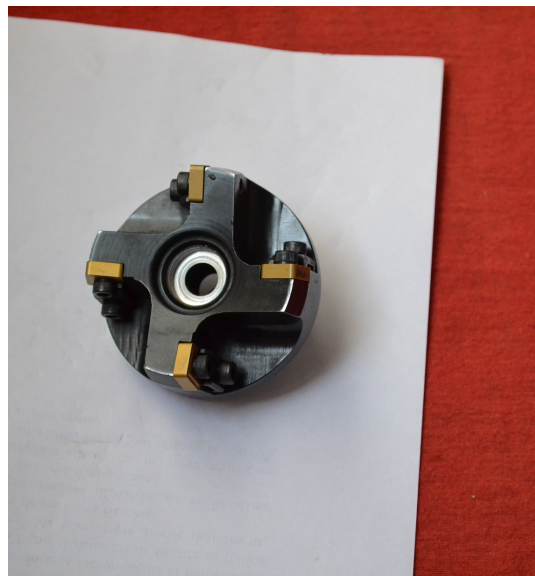
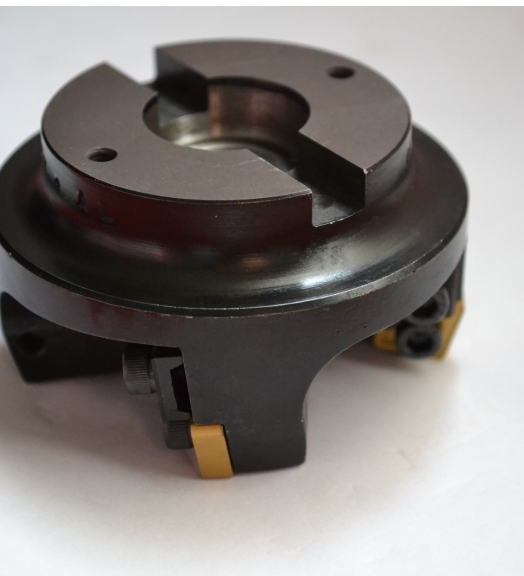

Herramientas

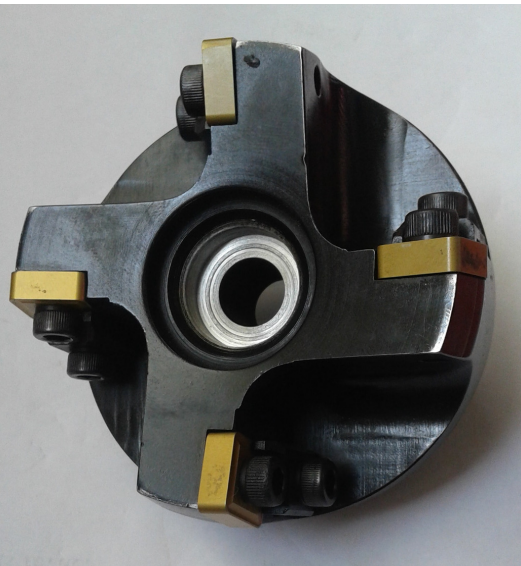

Herramientas

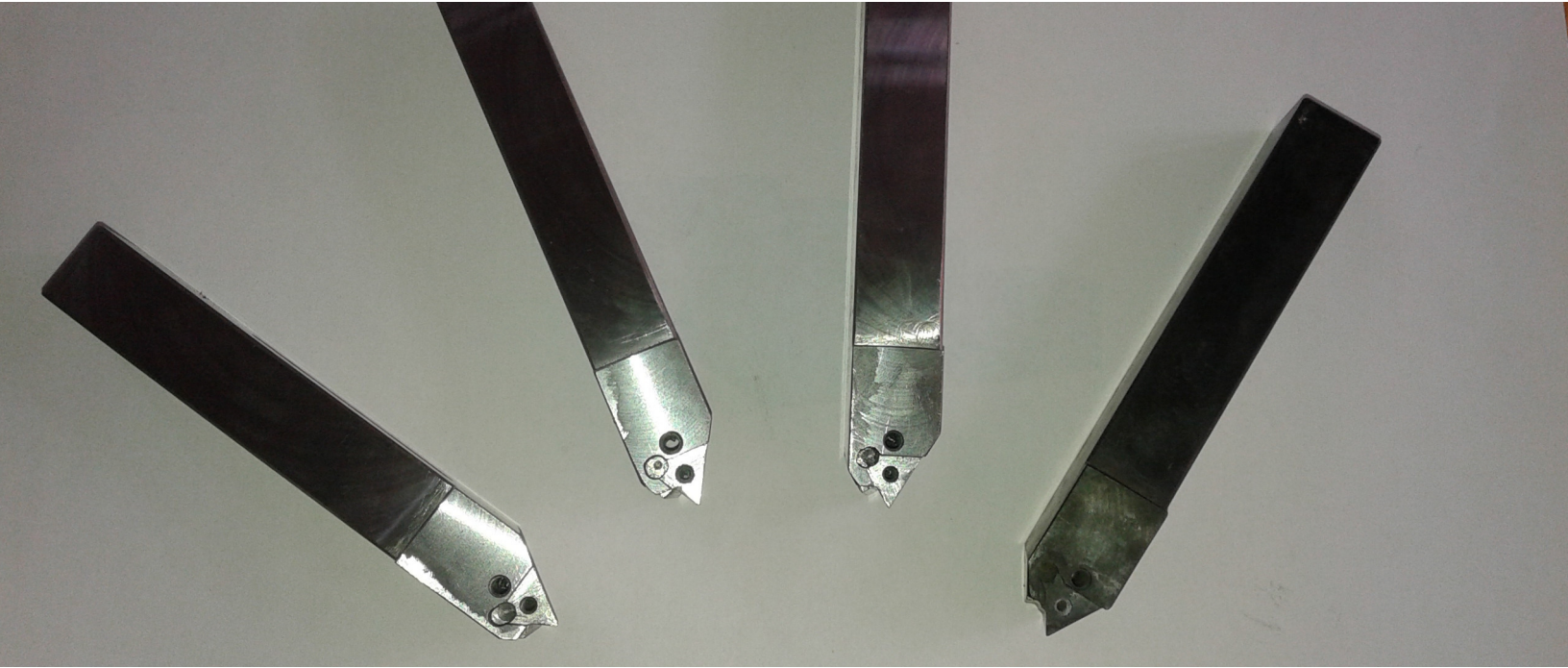

Herramientas

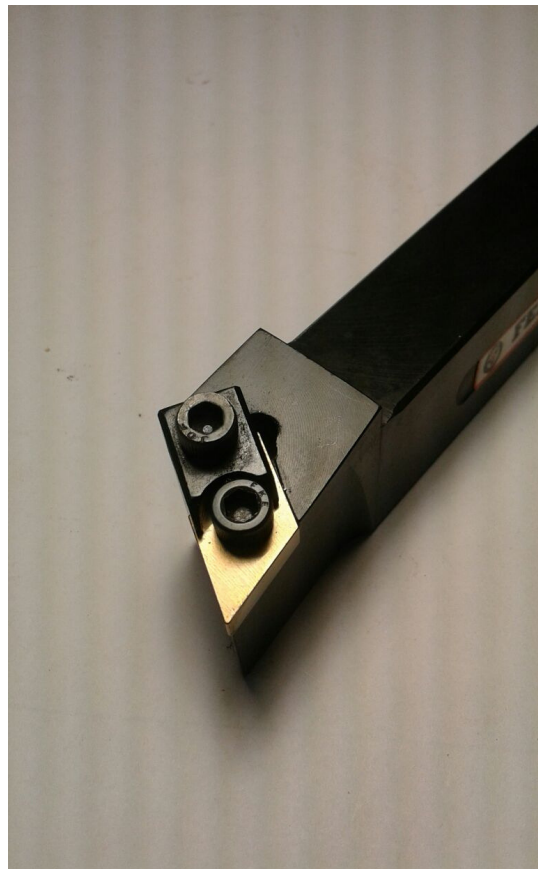

Herramientas



Herramientas

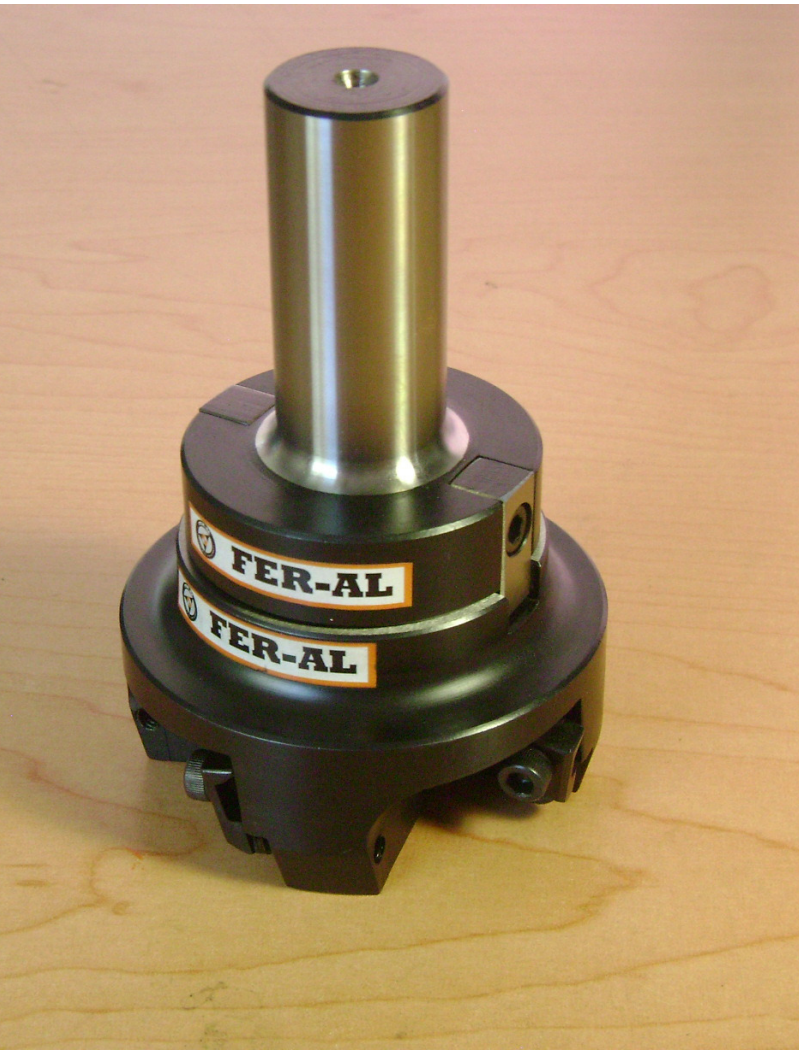
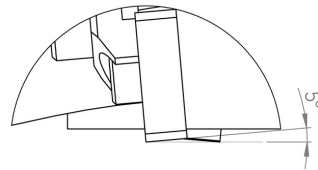
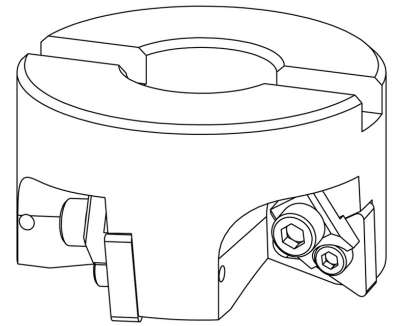
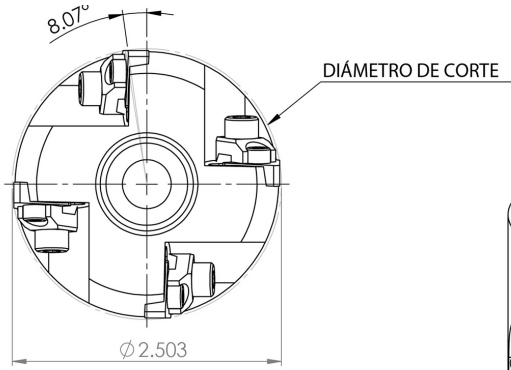

Herramientas



Herramientas



Personal





Fermín Cano Luna / Gerente General
Fermín Alejandro Cano Jiménez / Jefe de Taller
Mario González Cano / Informática y Marketing

fermin.cano@fer-al.com.mx
fermin.a.cano@fer-al.com.mx
mario.gc@fer-al.com.mx

